









**“Mavi Seri”
Konvansiyonel
Baca Sistemleri**













Mavi Seri Konvansiyonel Kombi Baca Aksesuarları

Ø 60/100 mm	Ürün Adı	Ürün Kodu
	(Ø 60/100 mm) Eş merkezli yatay set	3.017736
	(Ø 60/100 mm) Buzlanmaya karşı eş merkezli yatay baca seti	3.018210
	(Ø 60/100 mm) Eş merkezli dikey set (Bu ürün ile birlikte 4.011141 ve 4.016173 kodlu ürünlerin alınması zorunludur)	3.011698
	(Ø 60/100 mm) Flaşlı dikey tahliye adaptörü	3.011141
	(Ø 60/100 mm) Yoğuşuk tahliye adaptörü	3.016173
	(Ø 60/100 mm) Flaşlı 90° dirsek	3.011139
	(Ø 60/100 mm) 0,5 m baca uzatma borusu	3.018278
	(Ø 60/100 mm) 1,0 m baca uzatma borusu	3.018277
	(Ø 60/100 mm) 2,0 m baca uzatma borusu	3.010739
	(Ø 60/100 mm) 90° dirsek	3.018279
	(Ø 60/100 mm) 45° dirsek	3.010950

Ø 80/125 mm	Ürün Adı	Ürün Kodu
	(Ø 80/125 mm) Eş merkezli yatay set	3.010526
	(Ø 80/125 mm) Eşmerkezli dikey set	3.010352
	(Ø 80/125 mm) 0,5 m baca uzatma borusu	3.011157
	(Ø 80/125 mm) 1 m baca uzatma borusu	3.010945
	(Ø 80/125 mm) 2 m baca uzatma borusu	3.010946
	(Ø 80/125 mm) 90° dirsek	3.010951
	(Ø 80/125 mm) 45° dirsek	3.010952
	(Ø 80/125 mm) Yoğuşuk tahliye adaptörü	3.010960
Ø 80+80 mm	Ürün Adı	Ürün Kodu
	(Ø 80+80 mm) Ayrık baca kiti	3.010351

Mavi Seri Konvansiyonel Kombi Baca Aksesuarları

Ø 80+80	Ürün Adı	Ürün Kodu
	(Ø 80/125 mm) Dikey atık gaz tahliye kiti	3.010963
	(Ø 80+80 mm) Flanşlı dikey tahliye adaptör kiti	3.011570
	(Ø 80 mm) 1,0 m baca uzatma borusu 4 adet	3.010741
	(Ø 80 mm) 2,0 m baca uzatma borusu 4 adet	3.011167
	(Ø 80 mm) 90° dirsek (4 adet)	3.010955
	(Ø 80 mm) 45° dirsek (4 adet)	3.010956
	(Ø 80 mm) 90° dişi / dişi dirsek	3.011571
	(Ø 80 mm) Yoğuşuk tahliye adaptörü	3.012009
	(Ø 80 mm) Baca dişi/dişi dikey geçiş adaptörü	3.012714
	(Ø 80 mm) Atık gaz tahliye rüzgar kafesi	3.010962
	Dikey çıkış siperlik	3.011488

Konvansiyonel Kombi Baca Mesafeleri

Yatay eşmerkezli baca montaj mesafeleri



Ø 60 / 100 mm

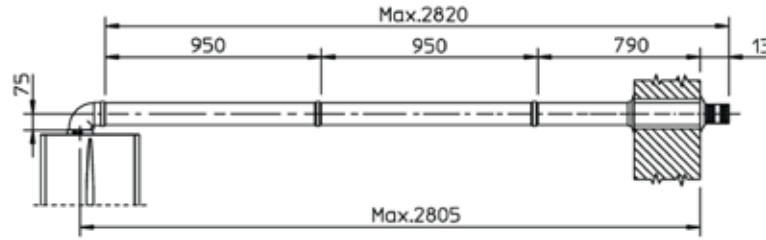

Ø 80 / 125 mm

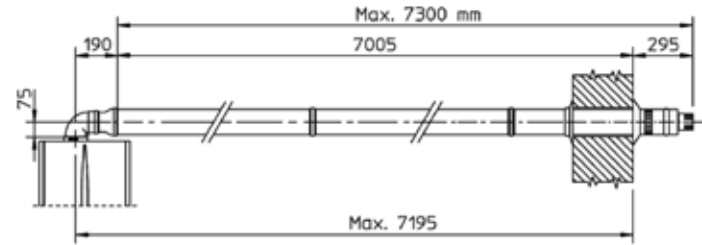

Dikey eşmerkezli baca montaj mesafeleri

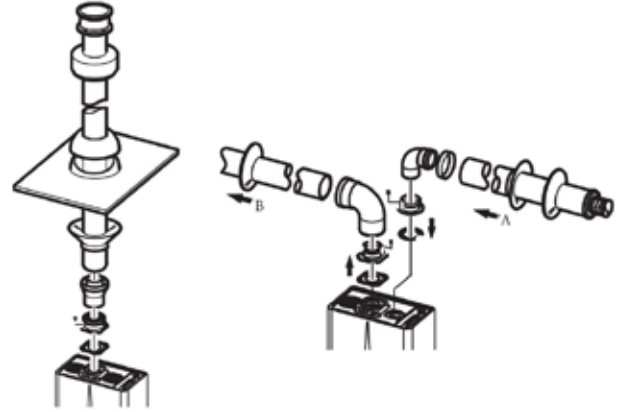

Ø 60 / 100 mm

Ø 80 / 125 mm

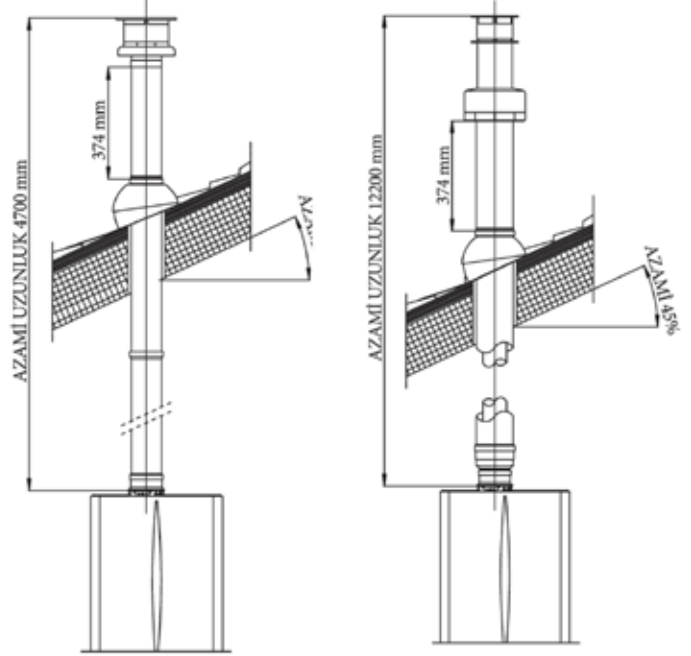

Eş merkezli baca sistemi ek dirsek parçaları için eşdeğer uzunluklar

Ø 60/100 Eş merkezli 90° köşe dirsek	4.018279		1,3 m
Ø 60/100 Eş merkezli 45° köşe dirsek	4.010950		1 m
Ø 80/125 Eş merkezli 90° köşe dirsek	4.010951		1,3 m
Ø 80/125 Eş merkezli 45° köşe dirsek	4.010952		1 m
Ø 60/100 den Ø 80/125'e yağışuk tahliye adaptörü	3.010960		2,2 m
Ø 60/100 den Ø 80/125'e eşmerkezli adaptör	3.010957		0,3

Ayrık baca sistemi ek dirsek parçaları için eşdeğer uzunluklar

Ø 80 Ayrık baca 90° köşe dirsek	4.010955		Temiz hava 2,2 m Atık gaz 2,1 m
Ø 80 Ayrık baca 45° köşe dirsek	4.010956		Temiz hava 1,3 m Atık gaz 1,3 m
Ø 80 Yoğuşuk tahliye adaptörü	3.012009		2,5 m

*Kombi atık gaz dirseğinin kaldırılması durumunda taze hava (emiş) boru mesafesi 2,5 m daha uzatılabilir,

*Taze hava emiş dirseğinin kaldırılması durumunda ise 2 m uzatılabilir,

*Her iki dirseğin de kaldırılmasıyla (**dikey konumda**) 4,5 m daha uzatılabilir.

Ayrık baca sistemi baca mesafeleri

Atık gaz baca mesafesi	Temiz hava baca mesafesi
1 m	36.0*
2 m	34.5*
3 m	33.0*
4 m	32.0*
5 m	30.5*